



VARTA SILVER dynamic AGM

Vehicle Key Benefits



Патентована PowerFrame® решетка за надеждна стартова мощност, бързо зареждане и устойчивост на корозия

For more information visit varta-automotive.com

ORDER INFORMATION

European Type No. (ETN):	580901080
Article Number:	580901080J382
Short Code:	A6
Barcode:	4016987165522
UK Code:	115AGM
Packaging Unit:	1
Quantity per Pallet:	36

TECHNICAL INFORMATION

Voltage [V]:	12	Base Hold-down:	B13
Battery Capacity [Ah]:	80	Layout:	0
CCA, EN [A]:	800	Terminal Types:	1
Length [mm]:	315	Case Size:	H7/LN4
Width [mm]:	175	Weight filled (kg):	22,76
Height [mm]:	190		

DRAWINGS

B13

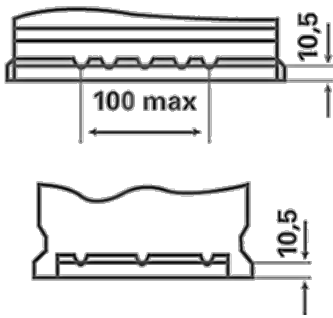

0

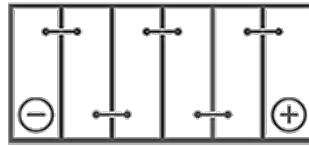

1

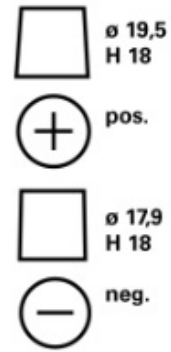

3

